



US007017687B1

(12) **United States Patent**
Jacobsen et al.

(10) **Patent No.:** **US 7,017,687 B1**
(45) **Date of Patent:** **Mar. 28, 2006**

(54) **RECONFIGURABLE ARTICULATED LEG AND WHEEL**

(75) Inventors: **Stephen Jacobsen**, Salt Lake City, UT (US); **Fraser M. Smith**, Salt Lake City, UT (US); **Marc Olivier**, Sandy, UT (US); **Christopher S. Maggio**, Salt Lake City, UT (US)

(73) Assignee: **Sarcos Investments LC**, Salt Lake City, UT (US)

(*) Notice: Subject to any disclaimer, the term of this patent is extended or adjusted under 35 U.S.C. 154(b) by 79 days.

(21) Appl. No.: **10/720,011**

(22) Filed: **Nov. 21, 2003**

Related U.S. Application Data

(60) Provisional application No. 60/428,512, filed on Nov. 21, 2002.

(51) **Int. Cl.**
B62D 57/02 (2006.01)

(52) **U.S. Cl.** **180/8.3**; 280/5.2; 901/1

(58) **Field of Classification Search** 180/7.1, 180/8.1-8.7; 280/5.2, 5.26; 901/1; 305/5.1, 305/60

See application file for complete search history.

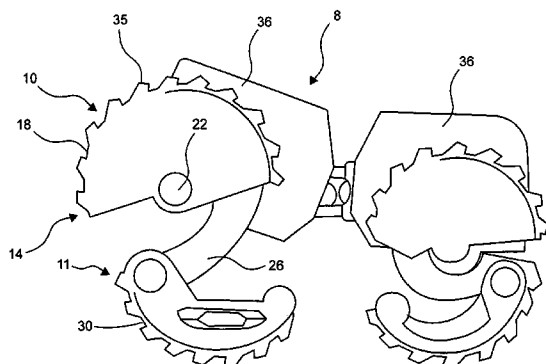

(56) **References Cited**

U.S. PATENT DOCUMENTS

792,403 A	6/1905	Crosse	
1,664,570 A	4/1928	Perilli	
1,670,100 A	5/1928	Deitrich	
2,941,846 A	6/1960	Hall et al.	
3,179,431 A	4/1965	Pikl	
4,241,803 A *	12/1980	Lauber	180/8.1
4,265,326 A	5/1981	Lauber	
4,558,758 A *	12/1985	Littman et al.	180/8.3
4,648,853 A *	3/1987	Siegfried	446/448
5,137,101 A *	8/1992	Schaeff	180/8.1
5,361,186 A	11/1994	Tanie et al.	
5,609,216 A	3/1997	Fisher et al.	
6,068,073 A	5/2000	Roston et al.	
6,082,475 A	7/2000	Ilikhanov	
6,397,960 B1	6/2002	Alber	
2002/0104692 A1	8/2002	Nakatsukasa et al.	

FOREIGN PATENT DOCUMENTS

JP 58167263 A * 10/1963 180/7.1

* cited by examiner

Primary Examiner—Lesley D. Morris

Assistant Examiner—L. Lum

(74) *Attorney, Agent, or Firm*—Thorpe North & Western

(57) **ABSTRACT**

A reconfigurable leg and wheel device includes an array of components joined in series configurable as i) an articulated leg with the components movable with respect to one another in a walking motion, and reconfigurable as ii) a wheel with the components forming a circular outer surface and being rotatable about an axis in a rotational motion.

19 Claims, 9 Drawing Sheets

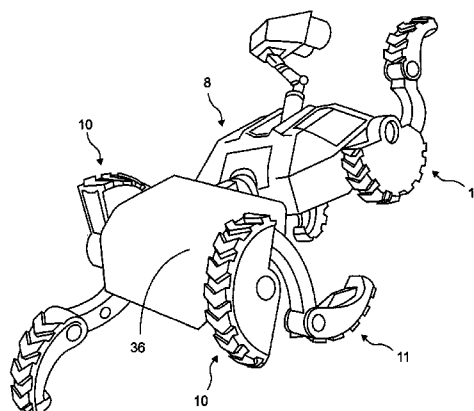

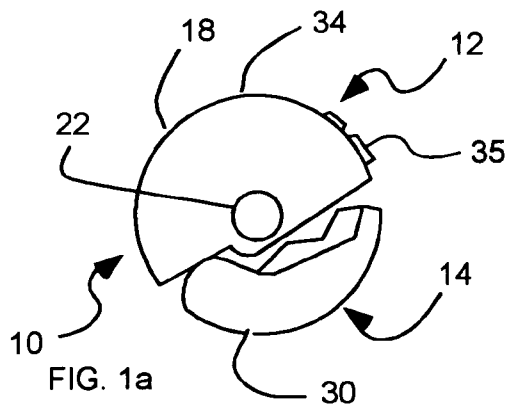

FIG. 1a

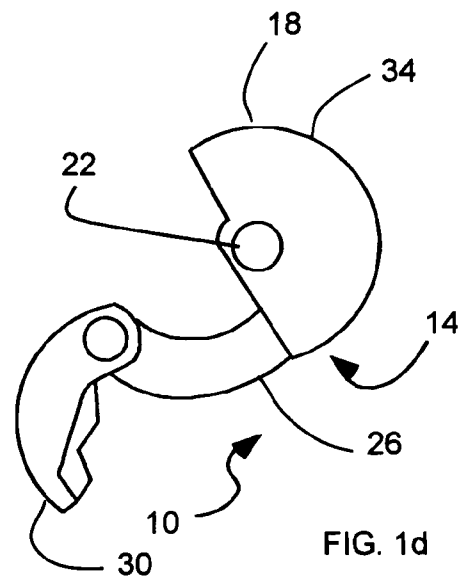

FIG. 1d

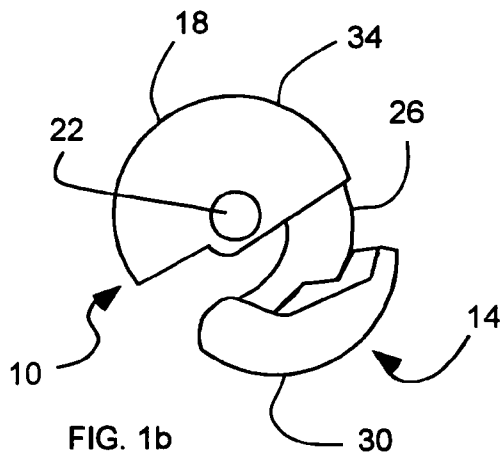

FIG. 1b

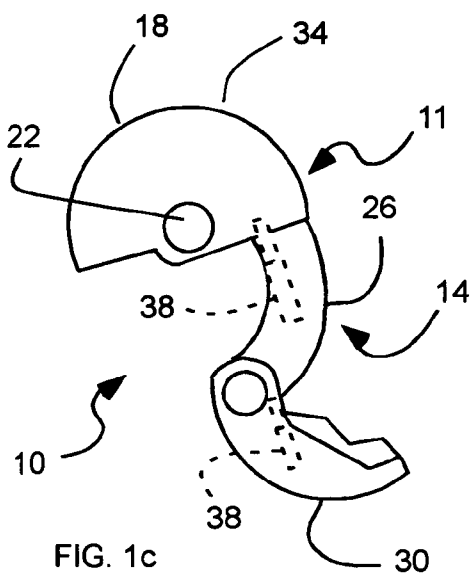

FIG. 1c

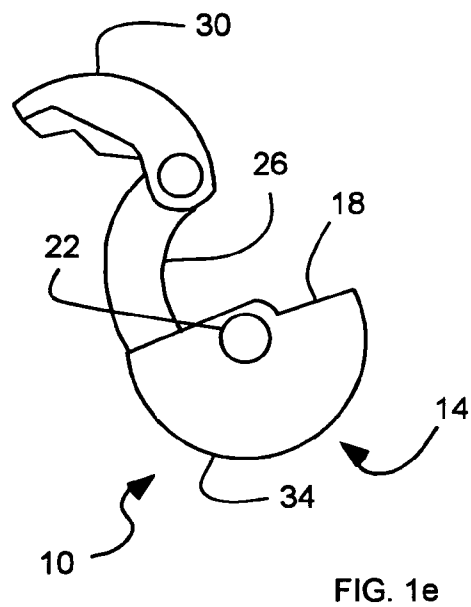

FIG. 1e

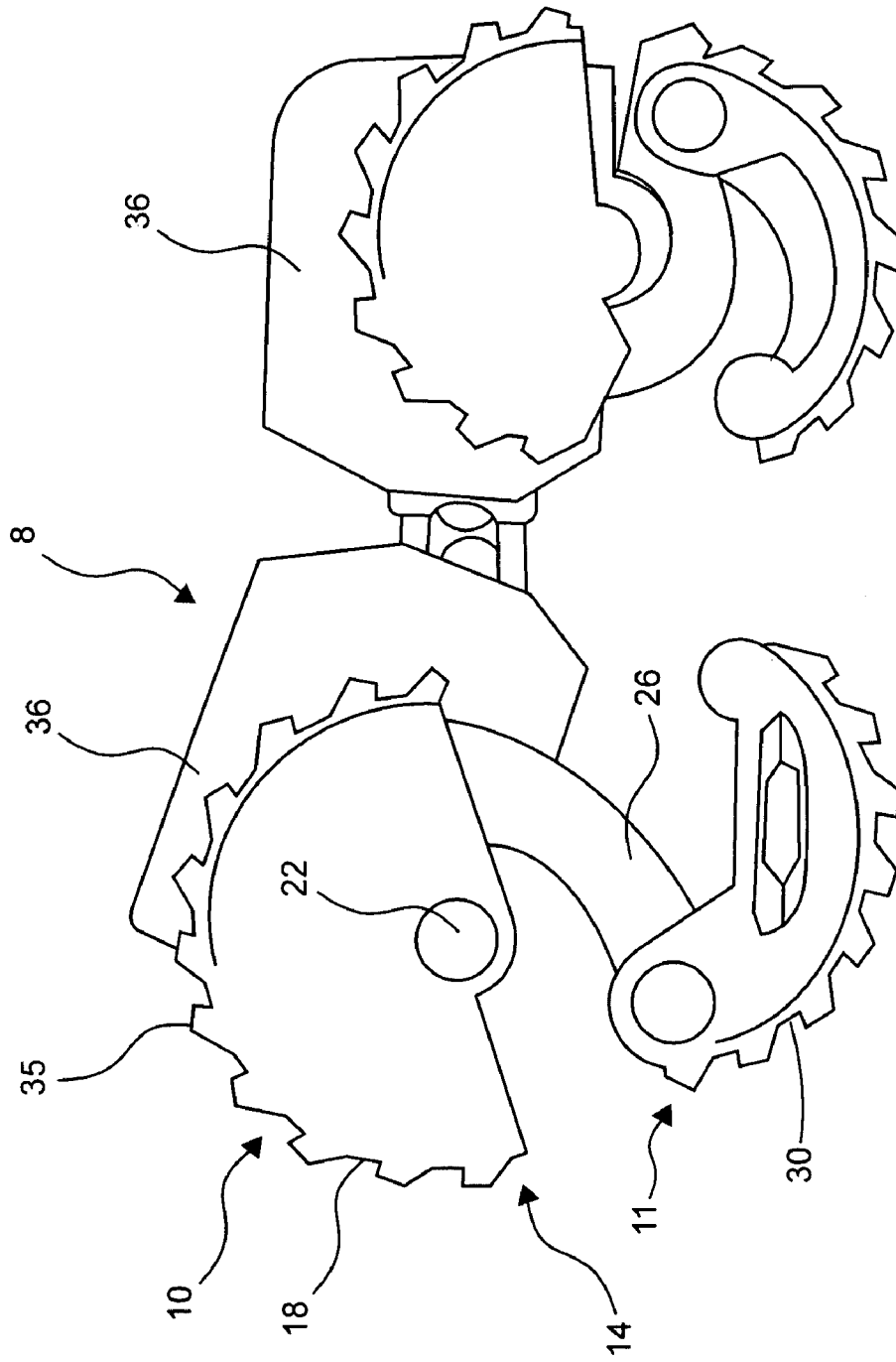

Fig. 2a

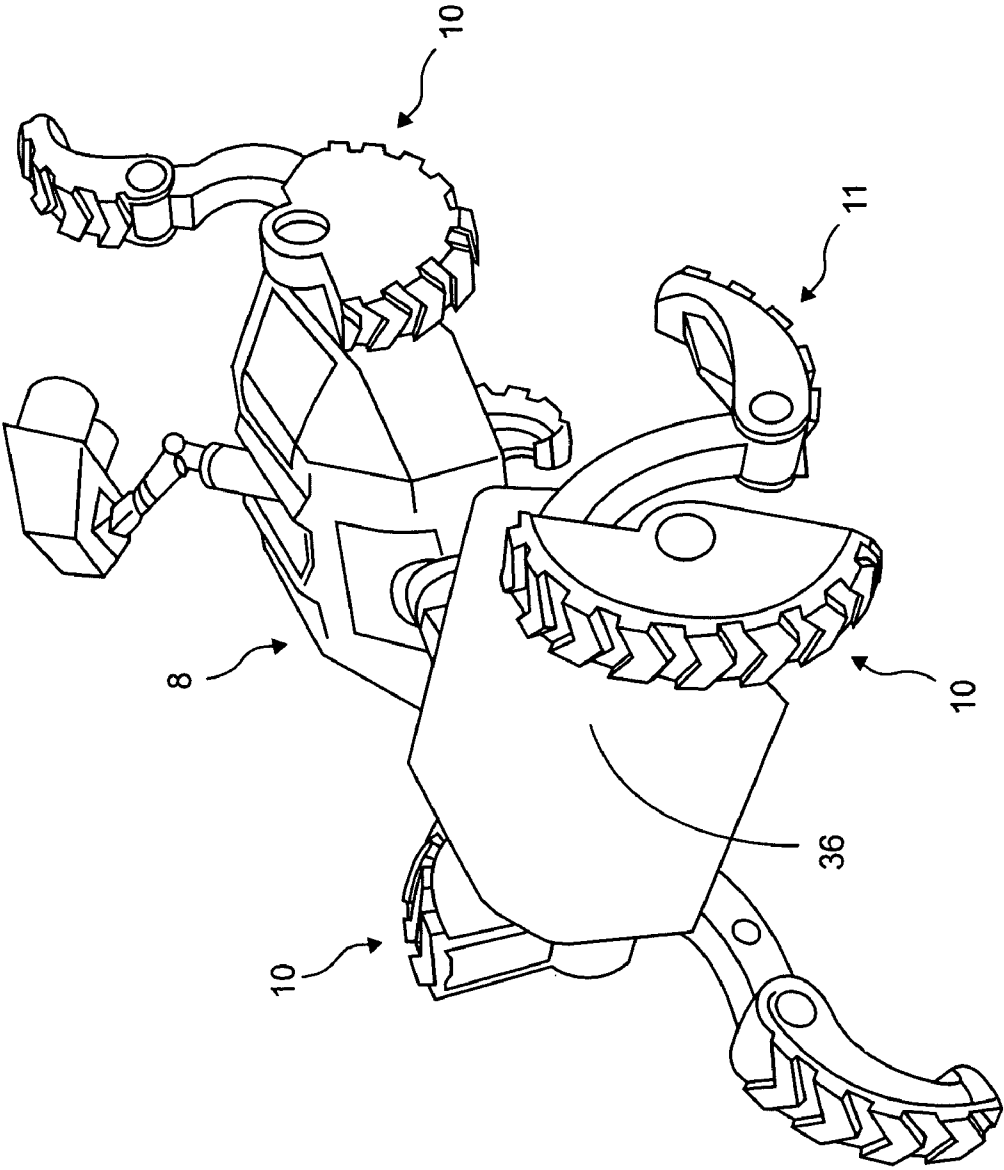

Fig. 2b

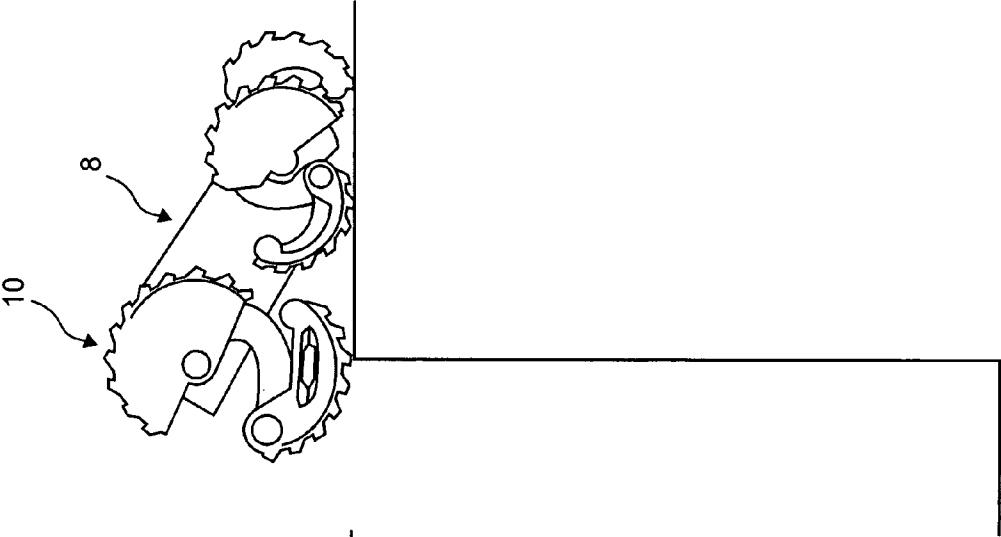

Fig. 3d

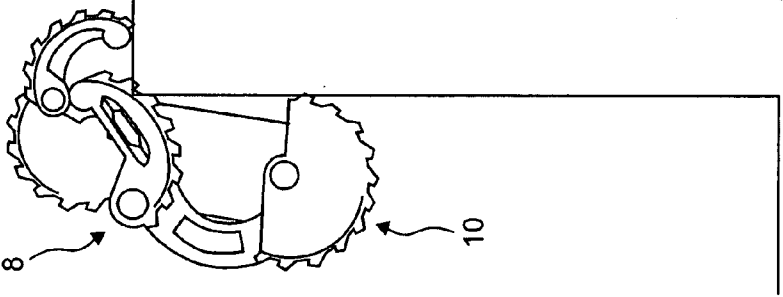

Fig. 3c

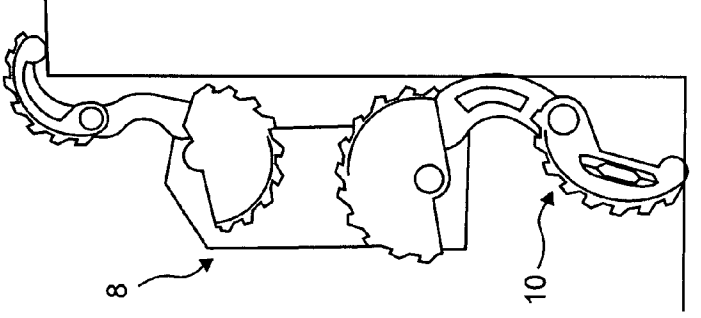

Fig. 3b

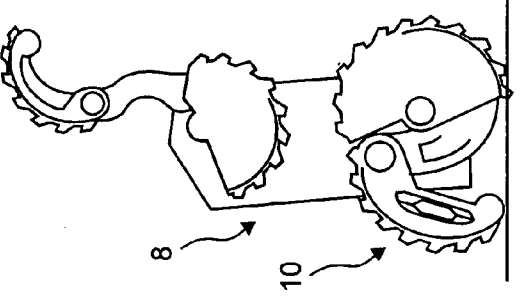
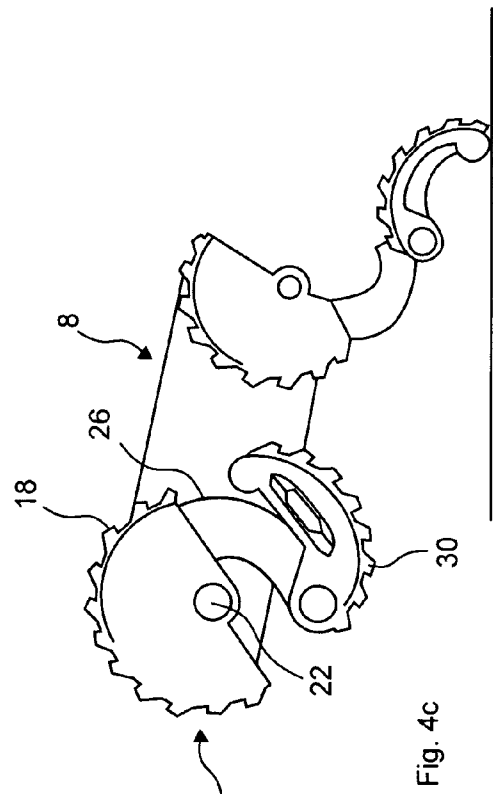
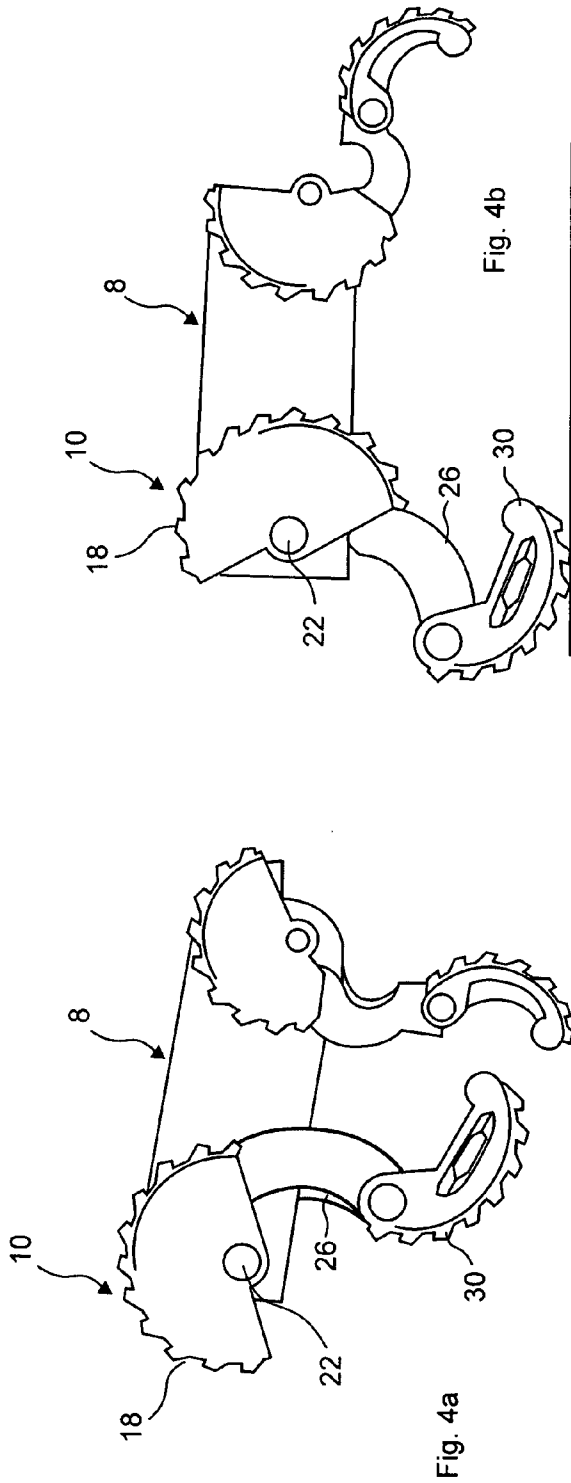

Fig. 3a



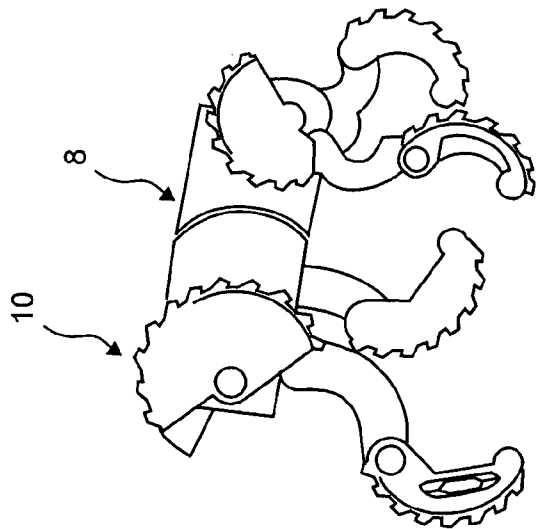

Fig. 5a

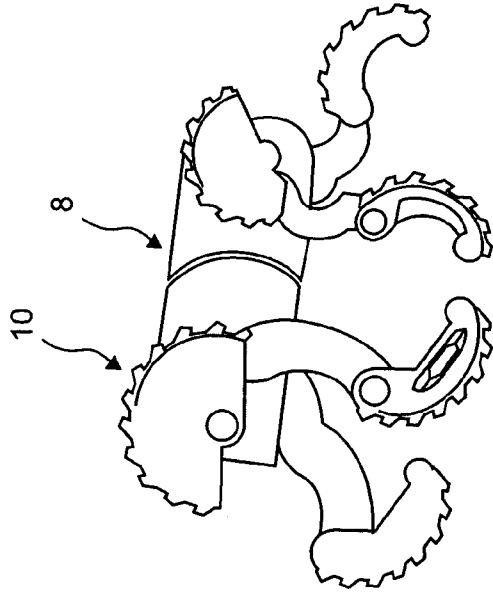

Fig. 5b

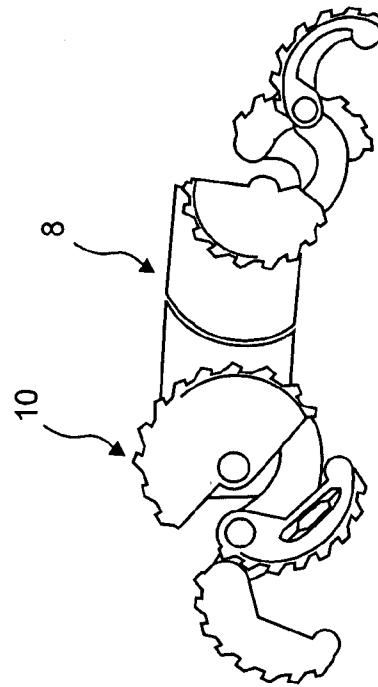

Fig. 5c

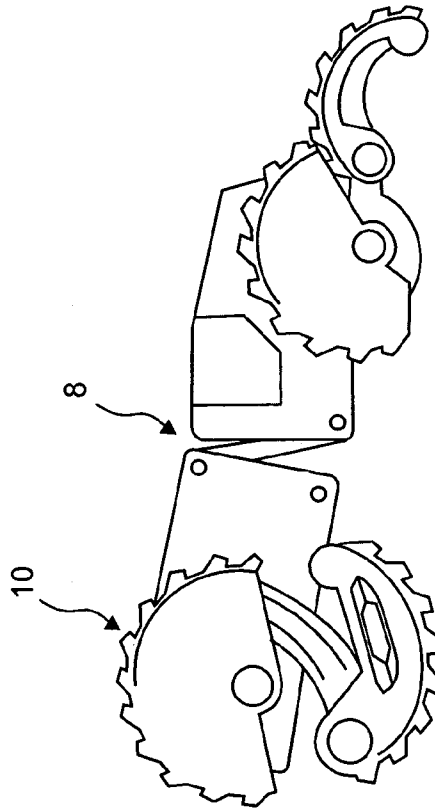

Fig. 5d

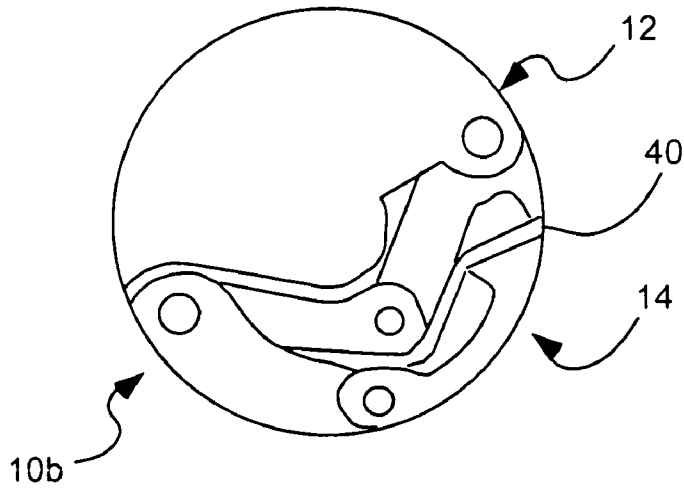

FIG. 6a

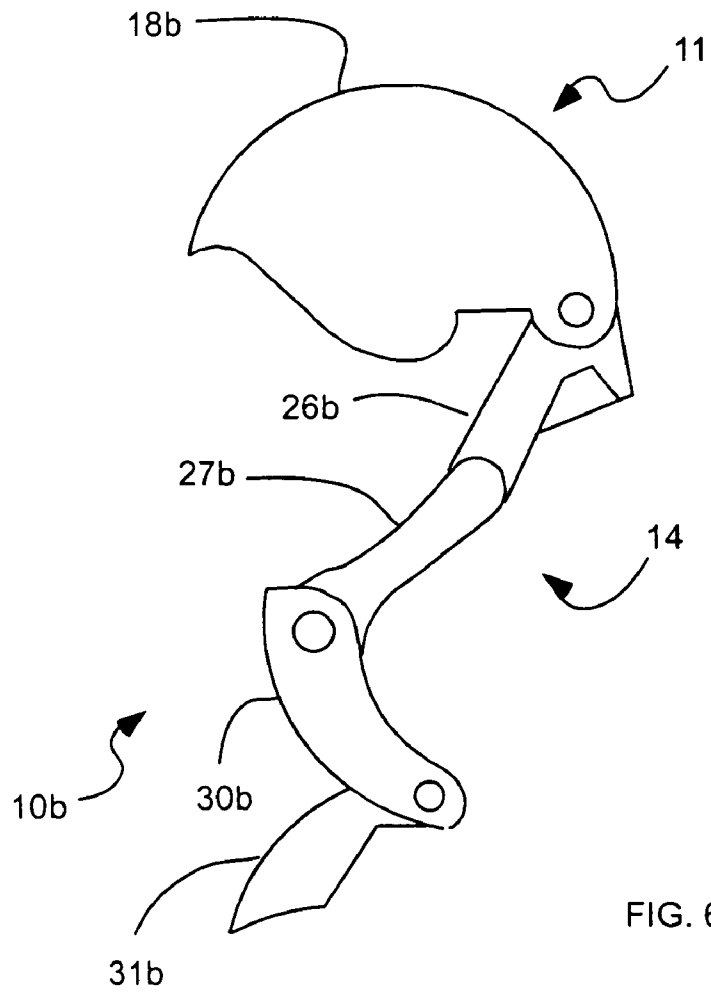

FIG. 6b

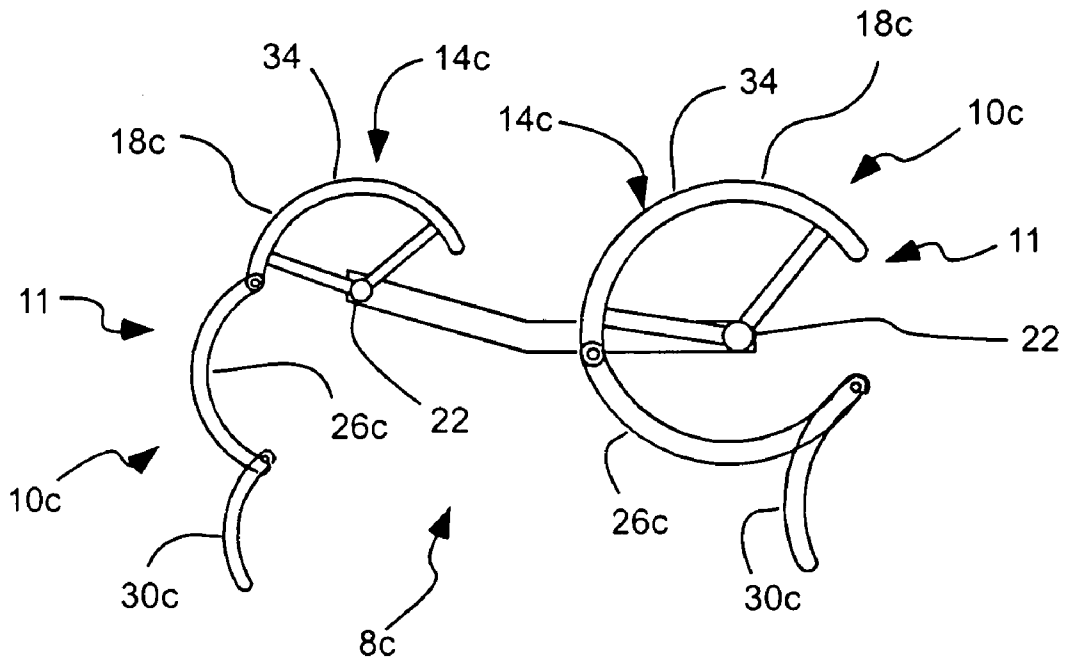

FIG. 7a

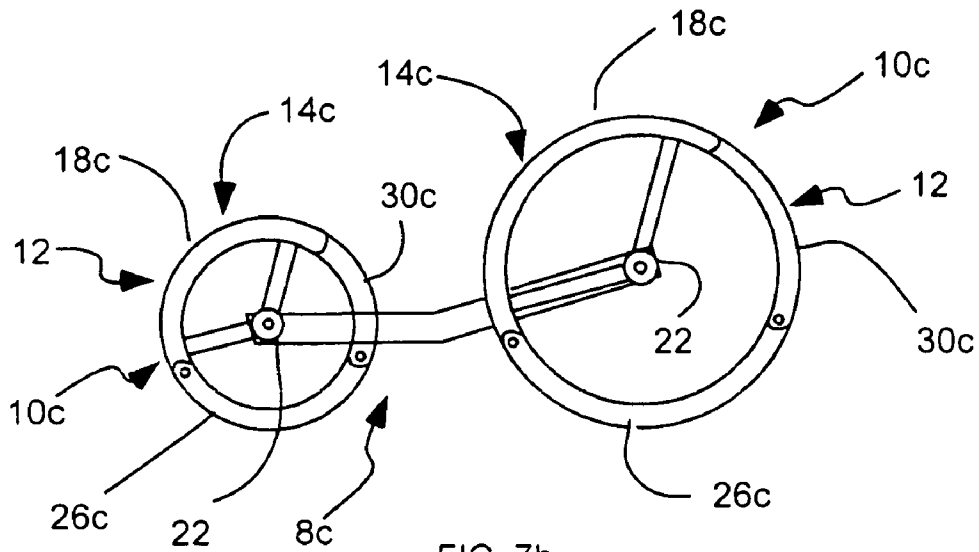

FIG. 7b

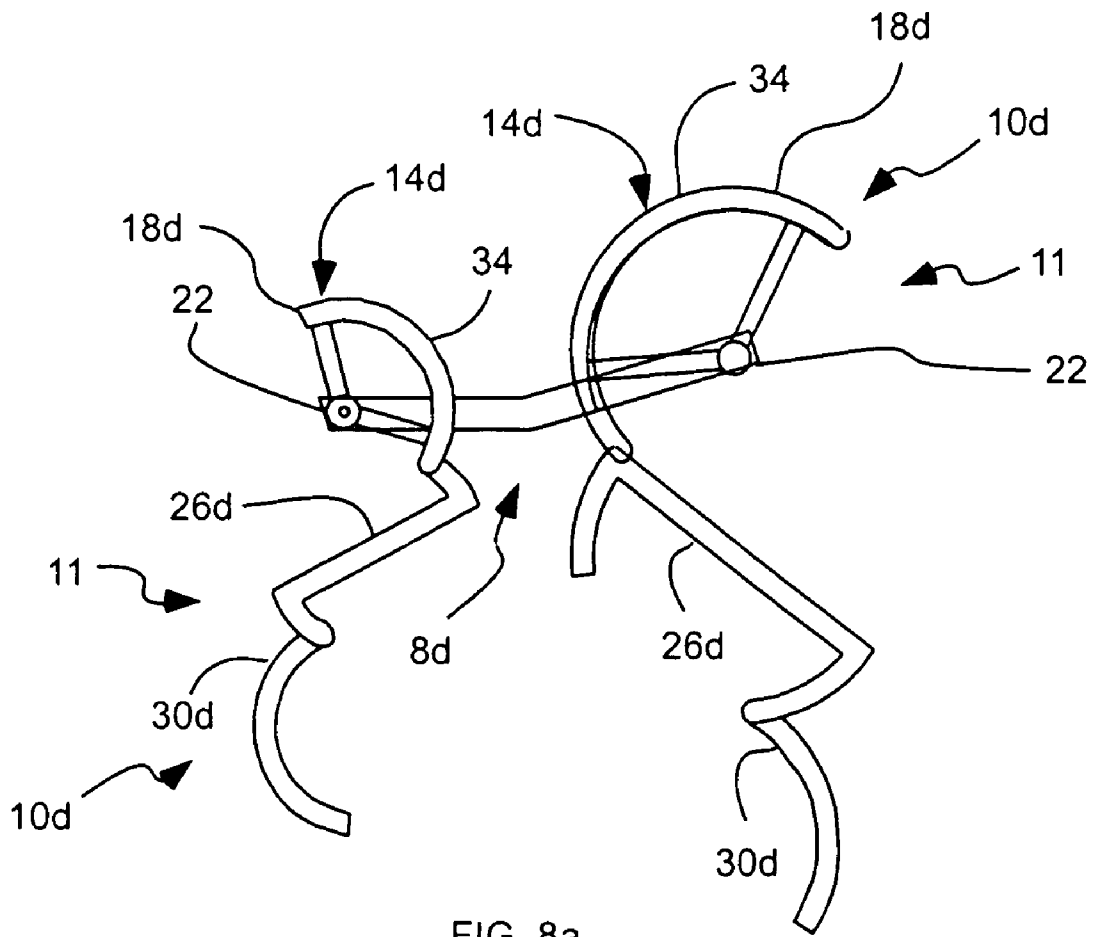

FIG. 8a

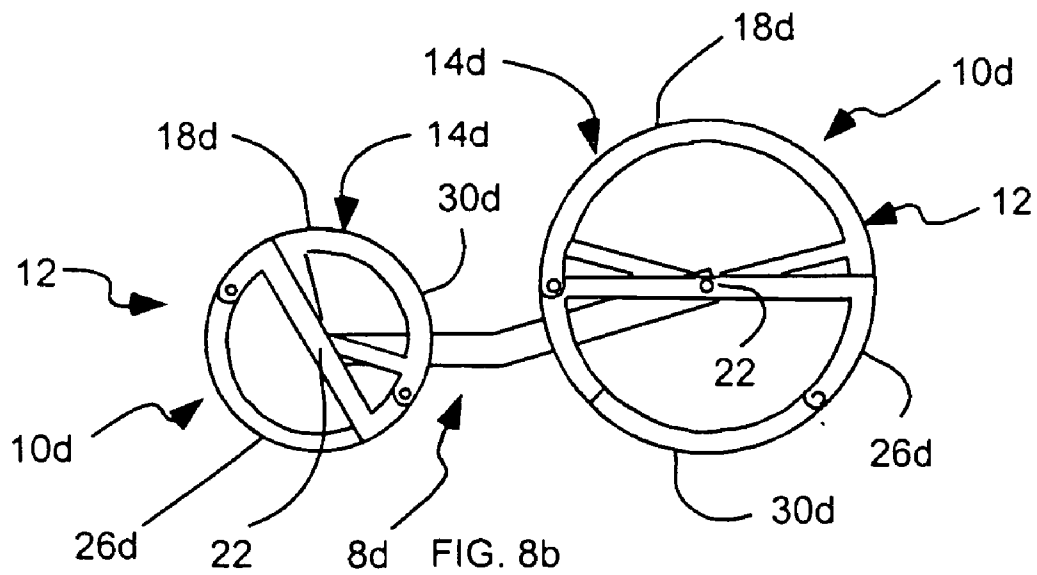

FIG. 8b

RECONFIGURABLE ARTICULATED LEG AND WHEEL

This application claims the benefit of U.S. Provisional Patent Application No. 60/428,512, filed Nov. 21, 2002.

BACKGROUND OF THE INVENTION

1. Field of the Invention

The present invention relates generally to robotics. More particularly, the present invention relates to an articulated leg that is configurable as a wheel.

2. Related Art

Improvement of robotics and/or robotic movement is a continuing pursuit. Wheeled transportation can be characterized by greater efficiency or speed, while articulated leg transportation can be characterized by greater flexibility for movement over complex terrain. Wheels can rotate quickly, but can have difficulty on uneven terrain, while articulated legs can negotiate the uneven terrain, but can have difficulty with speed. Such wheeled transport can have limited mobility and behavior due to complex environment and lack of adaptability to unpredictable terrain.

SUMMARY OF THE INVENTION

It has been recognized that it would be advantageous to develop a robot or a robotic transportation system capable of greater mobility, efficiency, and adaptability. In addition, it has been recognized that it would be advantageous to develop legs and/or wheels to facilitate mobility of vehicles or robots.

The invention provides a reconfigurable leg and wheel device with an array of components joined in series configurable as i) an articulated leg with the components movable with respect to one another in a walking motion, and reconfigurable as ii) a wheel with the components forming a circular outer surface and being rotatable about an axis in a rotational motion.

In accordance with a more detailed aspect of the present invention, the array of components can include a plurality of semi-circular segments combinable to form a substantially continuous circular surface to make rolling contact with a support surface.

Additional features and advantages of the invention will be apparent from the detailed description which follows, taken in conjunction with the accompanying drawings, which together illustrate, by way of example, features of the invention.

BRIEF DESCRIPTION OF THE DRAWINGS

FIGS. 1a-e are side views of a perspective view of a reconfigurable articulated leg and wheel in accordance with an embodiment of the present invention with FIG. 1a showing a wheel configuration and FIGS. 1b-e showing other configurations;

FIG. 2a is a side view of a vehicle with the reconfigurable articulated leg and wheel of FIGS. 1a-e; and

FIG. 2b is a perspective view of the vehicle of FIG. 2a;

FIGS. 3a-d are side views of the vehicle of FIG. 2a shown in a climbing configuration;

FIGS. 4a-c are side views of the vehicle of FIG. 2a shown in a bounding configuration;

FIGS. 5a and b are side views of the vehicle of FIG. 2a shown in a walking configuration;

FIG. 5c is a side view of the vehicle of FIG. 2a shown in a crawling configuration;

FIGS. 6a and b are side views of a reconfigurable articulated leg and wheel in accordance with an embodiment of the present invention with FIG. 6a showing a wheel configuration and FIG. 6b showing a leg or walking configuration;

FIGS. 7a and b are schematic side views of a reconfigurable articulated leg and wheel in accordance with an embodiment of the present invention with FIG. 7a showing a leg or walking configuration and FIG. 7b showing a wheel configuration; and

FIGS. 8a and b are schematic side views of a reconfigurable articulated leg and wheel in accordance with an embodiment of the present invention with FIG. 8a showing a leg or walking configuration and FIG. 8b showing a wheel configuration.

DETAILED DESCRIPTION

Reference will now be made to the exemplary embodiments illustrated in the drawings, and specific language will be used herein to describe the same. It will nevertheless be understood that no limitation of the scope of the invention is thereby intended. Alterations and further modifications of the inventive features illustrated herein, and additional applications of the principles of the inventions as illustrated herein, which would occur to one skilled in the relevant art and having possession of this disclosure, are to be considered within the scope of the invention.

As illustrated in FIGS. 1a-5c, a reconfigurable articulated leg and wheel (leg/wheel), indicated generally at **10**, in accordance with the present invention is shown for providing both walking and rolling motions or modes of transportation. The leg/wheel **10** can morph, transform, convert, or be reconfigured between leg and wheel configurations, or between a leg and a wheel, indicated respectively at **11** and **12**. A plurality of the legs/wheels **10** can be provided on a single vehicle, body or robot, indicated generally at **8**. For example, four legs/wheels **10** can be provided, as shown. Vehicles and robotics are examples of fields that can benefit from the use of such a leg/wheel **10**. The legs/wheels **10** can provide the robot **8** with mobility both quickly on flat surfaces, and efficiently on irregular surfaces. Such robots can be used in various different applications, including for example, military reconnaissance, biohazard, bomb analysis, etc.

The leg/wheel **10** can include an array of components or plurality of leg segments **14** joined in series. The leg segments **14** can be coupled end-to-end, with the ends of adjacent leg segments pivotally coupled together. The array of components or plurality of leg segments **14** can include 1) an upper leg **18** pivotally coupled at an axis **22** to the body, vehicle or robot **8**; 2) a lower or intermediate leg **26** pivotally coupled to the upper leg **18**; and 3) a foot **30** pivotally coupled to the lower leg **26**. The components or leg segments can include at least two leg segments, such as upper leg **18** and foot **30**, and at least one intermediate leg segment **26**.

The components or leg segments **14** can include a plurality of semi-circular segments or portions **34** that combine to form a continuous circular outer surface or wheel configured **12** to make rolling contact with a support surface, such as the ground. Only some of the leg segments **14** can include the semi-circular portions **34**, such as the upper leg **18** and the foot **30**, while other leg segments may not include a semi-circular portion, such as intermediate or lower leg **26**.

Thus, only some of the leg segments **14** may form the outer periphery or circumference of the wheel **12**. Alternatively, each leg segment **14** can include a semi-circular portion **34**.

The components or leg segments **14** can have various different lengths, and can form various different portions of the wheel **12**. The upper leg **18** can be sized, or can have a length, that forms a greater portion of the wheel. For example, the upper leg can form approximately $\frac{1}{3}$ to $\frac{1}{2}$ of the wheel. The intermediate or lower leg can form less than $\frac{1}{3}$ than the wheel. The foot **30** can form less than $\frac{1}{3}$ or $\frac{1}{4}$ of the wheel. The semi-circular segments or portions **34** can include a tread **35** (FIG. **1a**) or the like. In addition, portions of the leg segments **14** can fold into other or adjacent leg segments during use or in the wheel configuration **12**. For example, the intermediate or lower leg **26** can fold substantially into the upper leg **18** and foot **30**.

The components or leg segments **14** can be configurable as 1) an articulated leg **11** with the components movable with respect to one another in a walking motion (FIG. **1c**); and reconfigurable as 2) a wheel **12** with the components forming a circular outer surface and being rotatable about an axis in a rotational motion (FIG. **1b**). The components or leg segments **14** including at least two configurations, including a leg configuration **11** (FIG. **1c**) and a wheel configuration **12** (FIG. **1a**). In the leg configuration **11**, the leg segments **14** can be movable with respect to one another. The various leg segments **14** can pivot with respect to one another or adjacent segments in a walking motion, or the like. The leg configuration **11** can facilitate movement over rough or uneven terrain. In the wheel configuration **12**, the leg segments **14** can be rigidly affixed with respect to one another with the semi-circular portions **34** combined to form a substantial circular outer surface, and rotatable about an axis in a rotational motion. The wheel **12** can rotate about the axis or axle **22**. The wheel configuration **12** can allow the vehicle or robot **8** to move rapidly over smoother terrain.

Referring to FIGS. **1a-e**, the leg/wheel **10** is shown transforming or morphing between the wheel **12** or wheel configuration (FIG. **1a**) to various other configurations, including the leg **11** or leg configuration (FIG. **1c**). The leg can also be configured to reach or extend, such as in FIG. **1e**.

Referring to FIGS. **2a** and **2b**, the vehicle or robot **8** can include a plurality of such legs/wheels **10**, such as four. For example, the vehicle or robot **8** can have a pair of rear legs/wheels and a pair of front legs/wheels. The rear legs/wheels can be configured so that the intermediate leg **26** extends from a front of the upper leg **18** to a rear of the foot **30**. The front legs/wheels can be configured so that the intermediate leg **26** extends from a rear of the upper leg **18** to a front of the foot **30**.

The vehicle or robot **8** can have front and rear portions that are pivotally coupled to one another. The front and rear portions can be pivoted with respect to one another to turn the vehicle or robot. The vehicle or robot can include one or more power units or motors **36** that can be operatively coupled to the legs/wheels **10**. The power units or motors can rotate the wheels **12**. In addition, the power units or motors can pivot the upper legs **18**.

In addition, the legs/wheels **10** can include actuators **38** (FIG. **1c**) coupled to the components or leg segments **14** to move the components or leg segments with respect to each other in the leg configuration, and to reconfigure the components as the wheel **12**. The actuators can be of any known type, including for example, hydraulic cylinders, etc. The robot or body also can include a power source to power the actuators, and/or propel the wheels. The power source can be

of any known type. For example, the power and actuator systems can include a hydraulic motor and hydraulic actuators.

Referring to FIGS. **3a-d**, the vehicle or robot **8** is shown in a climbing mode or configuration. The movement of the various legs/wheels **10** can be coordinated to lift and pull the vehicle or robot **8** up a vertical step.

Referring to FIGS. **4a-c**, the vehicle or robot **8** is shown in a bounding mode or configuration. Again, the movement of the various legs/wheels **10** can be coordinated so that the vehicle or robot bounds. The bounding movement can mimic human or animal walking motions.

Referring to FIGS. **5a** and **b**, the vehicle or robot **8** is shown in a leg configuration with the legs in a walking movement. In FIG. **5c**, the vehicle or robot **8** is shown in a crawling mode or configuration, with the body, vehicle or robot lower to the ground.

Referring to FIGS. **6a** and **b**, another leg/wheel **10b** is shown that is similar in many respects to that described above. The leg/wheel **10b** can include a plurality of leg segments **14b**, including an upper leg **18b**, two intermediate legs **26b** and **27b**, and two feet **30b** and **31b**. Additional leg segments can provide for additional and more sophisticated movements and configurations.

The components or leg segments **14** or **14b** can arranged so that at least one of the leg segments, such as an intermediate legs **26**, **26b** and **27b** transverse the wheel in the wheel configuration, as shown in FIGS. **1a-6b**. The components or leg segments can also be arranged in series in the wheel configuration. Referring to FIGS. **7a** and **7b**, another leg/wheel **10c** and vehicle or robot **8c** are shown that are similar in many respects to those described above. The leg/wheel **10c** can include a plurality of leg segments **14c** that are pivotally coupled together in series, and that extend sequentially around the axis **22** in the wheel configuration (FIG. **7b**). For example, the upper leg **18c**, intermediate or lower leg **26c**, and the foot **30c** extend circumferentially around the axis **22** to form the wheel **12**.

Referring to FIGS. **8a** and **8b**, another leg/wheel **10d** and vehicle or robot **8d** are shown that are similar in many respects to those described above. The leg/wheel **10d** can include a plurality of leg segments **14d** that are pivotally coupled together in series, with the intermediate or lower leg **26d** extending transverse to the wheel **12** (FIG. **8b**). The leg segments **14d** can include the upper leg **18d**, intermediate or lower leg **26d**, and the foot **30d**. The intermediate leg **26d** can include at least a portion of the semi-circular portion **34**, and can form part of the wheel **12**.

The robot can be configured to provide various different functions, including surveillance, search and rescue, surface data, logistics support, detective, etc. Thus, the robot can include various different mechanisms, including cameras, sensors, robotic arms and/or grips, etc. The robot can include various communications equipment, such as receiver/transmitter to send and receive data and/or instructions. The robot also can include a global position system (GPS) to facilitate positioning. The robot also can include a controller, control circuitry, or computer to control and operate the robot, mechanisms, etc. The robot also can be configured to carry items, such as batteries, fuel, food/water, medical supplies, etc.

The legs/wheels **10** and the robot can be configured to perform various different movements, including crawl or caterpillar action, drop and roll, jump, flip, climb, walking, rolling, trotting, galloping, bounding, pronging, standing, balancing, sitting, stumble and fall recovery, etc.

5

The legs/wheels can be configured so that substantially all of the components **14** fit within a circumference defined by the wheel **12**.

The legs/wheels also can include retractable traction elements, such as claws. Such elements can be deployed from the legs or wheels.

A circular cap **40** (FIG. **6a**) can be disposed over the components when reconfigured as the wheel. The cap can protect the components.

It is to be understood that the above-referenced arrangements are illustrative of the application for the principles of the present invention. It will be apparent to those of ordinary skill in the art that numerous modifications can be made without departing from the principles and concepts of the invention as set forth in the claims.

What is claimed is:

1. A reconfigurable leg and wheel device, comprising: an array of components joined in series configurable as i) an articulated leg with an upper leg pivotally coupled to an axis to a body, a lower leg pivotally coupled to the upper leg, and a foot pivotally coupled to the lower leg, the upper leg, the lower leg and the foot movable with respect to one another in a walking motion, and reconfigurable as ii) a wheel with the upper leg, the lower leg and the foot forming a circular outer surface and being rotatable about an axis in a rotational motion.

2. A device in accordance with claim **1**, wherein the array of components further includes:

a plurality of semi-circular segments combinable to form a substantially continuous circular surface configured to make rolling contact with a support surface.

3. A device in accordance with claim **1**, wherein the array of components includes:

a) at least two leg segments having semi-circular portions; and

b) at least one intermediate leg segment interconnecting the at least two leg segments.

4. A device in accordance with claim **1**, further comprising:

at least one actuator, coupled between at least two of the components, to articulately move the components with respect to each other in the walking motion, and to reconfigure the components as the wheel.

5. A device in accordance with claim **1**, further comprising:

a circular cap, disposable over the components when reconfigured as the wheel.

6. A device in accordance with claim **1**, wherein one of the components is coupled to the axis and remaining components extend sequentially around the axis when reconfigured as the wheel.

7. A device in accordance with claim **1**, wherein at least one of the components extends transversely to the wheel when the components are reconfigured as the wheel.

8. A combined and transformable wheel and leg device, comprising:

a) a plurality of leg segments pivotally joined in series; b) the leg segments including at least two leg segments having semi-circular portions;

c) at least one intermediate leg segment interconnecting the at least two leg segments; and

c) the leg segments defining at least two configurations, including:

i) a leg configuration in which the leg segments are movable with respect to one another; and

ii) a wheel configuration in which the leg segments are rigidly affixed with respect to one another, and the

6

semi-circular portions are combined to form a substantial circular outer surface, and being rotatable about an axis in a rotational motion.

9. A device in accordance with claim **8**, wherein the plurality of leg segments further includes:

a) an upper leg pivotally coupled to the axis to a body;

b) a lower leg pivotally coupled to the upper leg; and

c) a foot pivotally coupled to the lower leg.

10. A device in accordance with claim **8**, further comprising:

at least one actuator, coupled between at least two leg segments, to move the leg segments with respect to each other in the leg configuration.

11. A device in accordance with claim **8**, further comprising:

a circular cap, disposable over the leg segments in the wheel configuration.

12. A device in accordance with claim **8**, wherein one of the leg segments is coupled to the axis and remaining leg segments extend sequentially around an axis in the wheel configuration.

13. A device in accordance with claim **8**, wherein at least one of the leg segments extends transversely to one of the other leg segments in the wheel configuration.

14. A combined and transformable wheel and leg device, comprising:

a) an array of leg segments pivotally joined in series, including at least:

i) an upper leg pivotally coupled to an axis to a body; and

ii) a lower leg pivotally coupled to the upper leg;

b) a plurality of semi-circular portions, associated with at least some of the leg segments;

c) the leg segments defining at least two configurations, including:

i) a leg configuration in which the leg segments are movable with respect to one another; and

ii) a wheel configuration in which the leg segments are rigidly affixed with respect to one another, and the semi-circular portions are combined to form a substantial circular outer surface, and being rotatable about an axis in a rotational motion;

d) actuators, coupled between adjacent leg segments, to move the leg segments with respect to each other in the walking configuration.

15. A device in accordance with claim **14**, wherein the plurality of leg segments further includes a foot pivotally coupled to the lower leg.

16. A device in accordance with claim **14**, wherein the plurality of leg segments further includes at least one intermediate leg segment interconnecting the upper and lower legs.

17. A device in accordance with claim **14**, further comprising:

a circular cap, disposable over the leg segments in the wheel configuration.

18. A device in accordance with claim **14**, wherein remaining leg segments extend from the upper leg sequentially around an axis in the wheel configuration.

19. A device in accordance with claim **14**, wherein at least one of the leg segments extends transversely to one of the other leg segments in the wheel configuration.